

WOLFFKRAN



Aiming high and by your side



WOLFFKRAN – THE RIGHT CHOICE

You have the challenge. We have the experience.

WOLFFKRAN: the leader of the pack. As inventor of the modern tower crane, WOLFFKRAN is the leading specialist of top slewing tower cranes worldwide.

WOLFFKRAN offers a portfolio of more than 20 various types of top slewing saddle jib and luffing jib tower cranes. Thus, offering you the right solution for every task.

Combining more than 150 years of experience with in-depth client service and our tower crane specialization makes WOLFF cranes synonymous with reliability and efficiency. A clear, modular structure, numerous intelligent and practical details, as well as highest quality “Made in Germany” distinguish a genuine WOLFF from the rest.

You can buy or rent your WOLFF crane - entirely flexible to suit your needs. WOLFF also offers you comprehensive, supplementary services such as site planning and logistics, assembly, training, maintenance and repairs – always direct from the original source and experienced specialists.

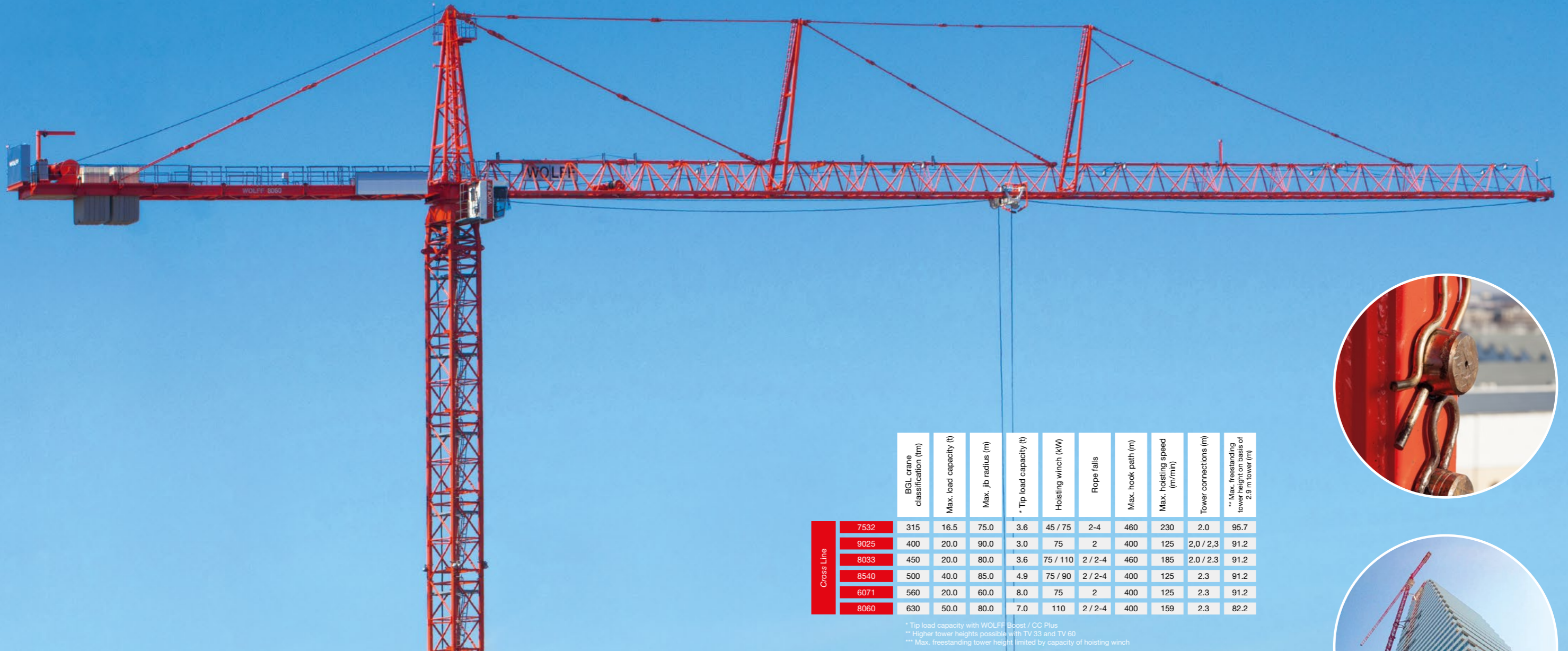

	BGL crane classification (tm)	Max. load capacity (t)	Max. jib radius (m)	* Tip load capacity (t)	Hoisting winch (kW)	Rope falls	Max. hook path (m)	Max. hoisting speed (m/min)	Tower connections (m)	** Max. freestanding tower height on basis of 2.9 m tower (m)	
Cross Line	7532	315	16.5	75.0	3.6	45 / 75	2-4	460	230	2.0	95.7
	9025	400	20.0	90.0	3.0	75	2	400	125	2.0 / 2.3	91.2
	8033	450	20.0	80.0	3.6	75 / 110	2 / 2-4	460	185	2.0 / 2.3	91.2
	8540	500	40.0	85.0	4.9	75 / 90	2 / 2-4	400	125	2.3	91.2
	6071	560	20.0	60.0	8.0	75	2	400	125	2.3	91.2
	8060	630	50.0	80.0	7.0	110	2 / 2-4	400	159	2.3	82.2

* Tip load capacity with WOLFF Boost / CC Plus
 ** Higher tower heights possible with TV 33 and TV 60
 *** Max. freestanding tower height limited by capacity of hoisting winch



OUR GIANT

WOLFF cross – heavy loads at maximum height.

The WOLFF cross saddle jib tower crane is available from 250 tm up to 630 tm with hoisting winches from 45 kW up to 110 kW.

The original WOLFF cross tower crane is the premier choice when it comes to large, heavy loads. The WOLFF cross series – like every WOLFF – features the original WOLFF pin connections for an exceptionally simple and secure assembly. The tower element's modular design allow for flexible combinations of tower sizes and thus providing optimal use.

Like every WOLFF, the modular cross frame and unique foundation anchor system make the WOLFF cross particularly economical. Just like the standardized counter weights, they considerably reduce transportation and assembly costs. Not to mention the proven reliability and safety record of the WOLFF cross cranes.

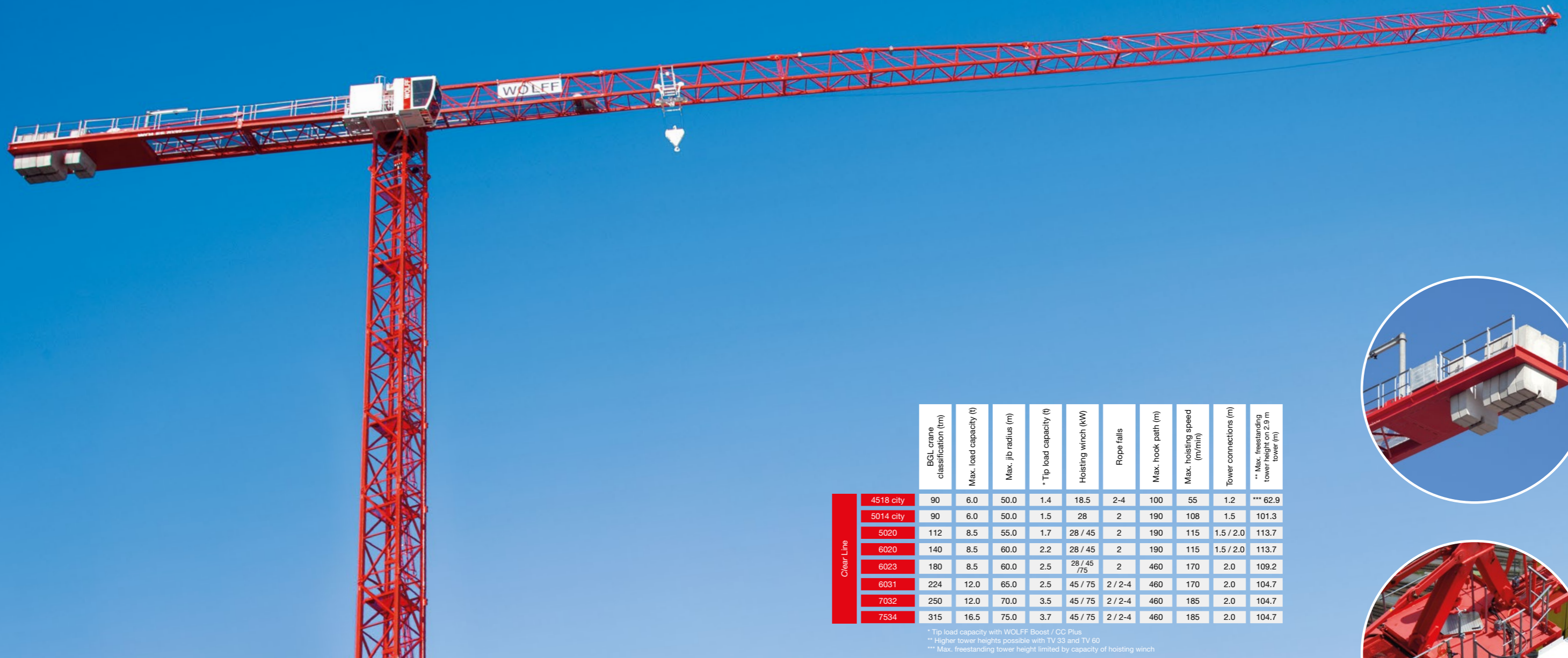

	BGL crane classification (tm)	Max. load capacity (t)	Max. jib radius (m)	* Tip load capacity (t)	Hoisting winch (kW)	Rope falls	Max. hook path (m)	Max. hoisting speed (m/min)	Tower connections (m)	** Max. freestanding tower height on 2.9 m tower (m)	
Clear Line	4518 city	90	6.0	50.0	1.4	18.5	2-4	100	55	1.2	*** 62.9
	5014 city	90	6.0	50.0	1.5	28	2	190	108	1.5	101.3
	5020	112	8.5	55.0	1.7	28 / 45	2	190	115	1.5 / 2.0	113.7
	6020	140	8.5	60.0	2.2	28 / 45	2	190	115	1.5 / 2.0	113.7
	6023	180	8.5	60.0	2.5	28 / 45 / 75	2	460	170	2.0	109.2
	6031	224	12.0	65.0	2.5	45 / 75	2 / 2-4	460	170	2.0	104.7
	7032	250	12.0	70.0	3.5	45 / 75	2 / 2-4	460	185	2.0	104.7
	7534	315	16.5	75.0	3.7	45 / 75	2 / 2-4	460	185	2.0	104.7

* Tip load capacity with WOLFF Boost / CC Plus
 ** Higher tower heights possible with TV 33 and TV 60
 *** Max. freestanding tower height limited by capacity of hoisting winch



OUR ALL-ROUNDER

WOLFF clear – high efficiency at every construction site.

The flat top WOLFF clear saddle jib tower crane is available from 80 tm up to 315 tm with hoisting winches from 28 kW up to 75 kW. Our new WOLFF 7534 clear is the most powerful in its class – with a 3.4 t tip load capacity and a working radius of 75 m.

The WOLFF clear series incorporates the strengths of WOLFF cross and delivers even more efficiency, thanks to fewer components and its quick assembly.

The clutter-free tower top of the WOLFF clear comes as a pre-assembled unit ex works. It allows for easy access to the notably compact counter jib and cabin platform, which is transportable and mountable as a whole. The hoisting drive, which is positioned on the counter jib is also easily accessible.

Unified counter weight blocks make for added simplicity and prevent the likelihood of weight calculation errors. Depending on the size of the crane, the counter jib is partially collapsible – considerably easing location transfers. Nevertheless, even long-distance transport is simple: the WOLFF clear cranes conform to container shipping.

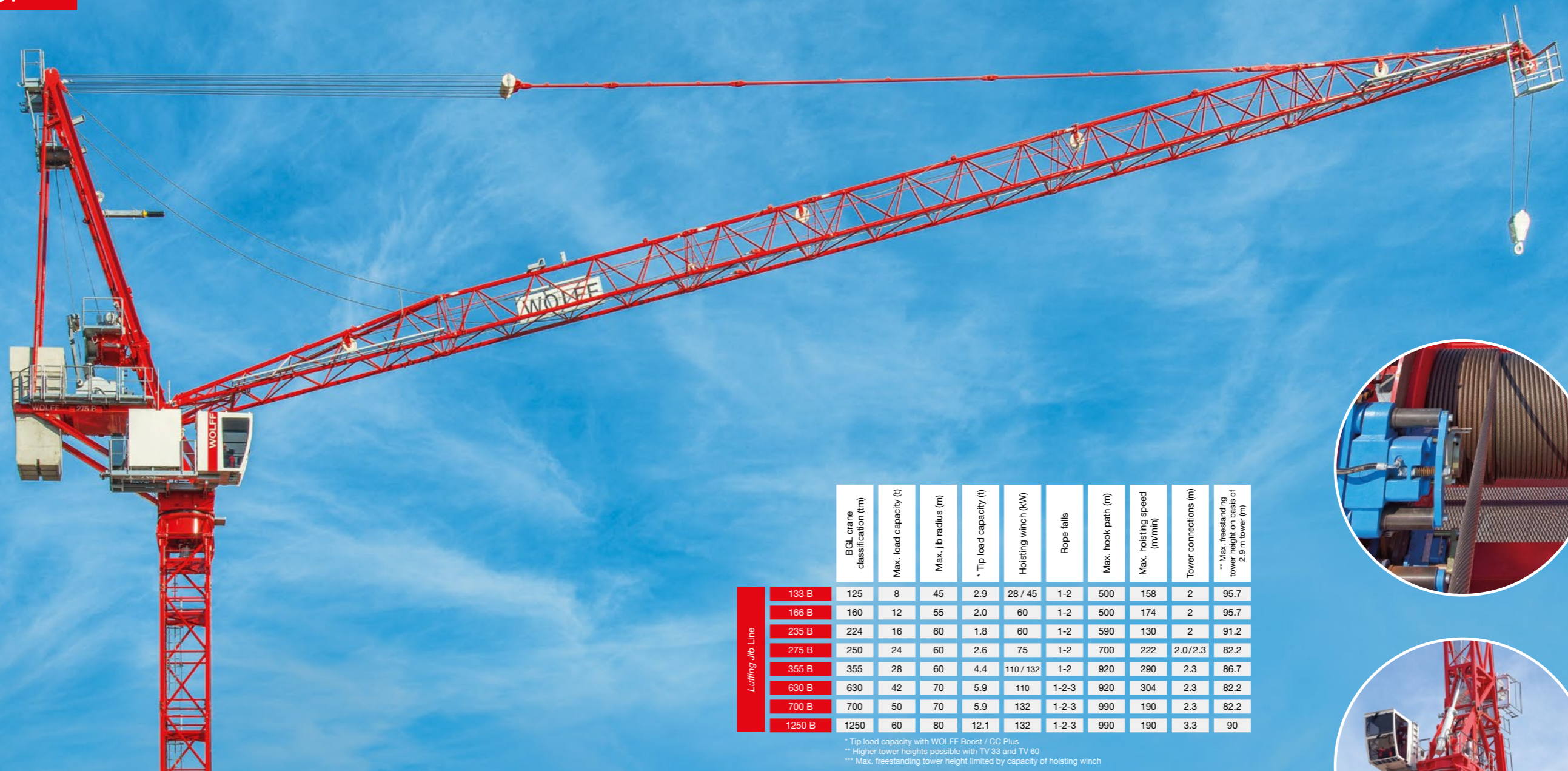

	BGL crane classification (tm)	Max. load capacity (t)	Max. jib radius (m)	* Tip load capacity (t)	Hoisting winch (kW)	Rope falls	Max. hook path (m)	Max. hoisting speed (m/min)	Tower connections (m)	** Max. freestanding tower height on basis of 2,9 m tower (m)	
Luffing Jib Line	133 B	125	8	45	2.9	28 / 45	1-2	500	158	2	95.7
	166 B	160	12	55	2.0	60	1-2	500	174	2	95.7
	235 B	224	16	60	1.8	60	1-2	590	130	2	91.2
	275 B	250	24	60	2.6	75	1-2	700	222	2,0/2,3	82.2
	355 B	355	28	60	4.4	110 / 132	1-2	920	290	2,3	86.7
	630 B	630	42	70	5.9	110	1-2-3	920	304	2,3	82.2
	700 B	700	50	70	5.9	132	1-2-3	990	190	2,3	82.2
	1250 B	1250	60	80	12.1	132	1-2-3	990	190	3,3	90

* Tip load capacity with WOLFF Boost / CC Plus
 ** Higher tower heights possible with TV 33 and TV 60
 *** Max. freestanding tower height limited by capacity of hoisting winch



OUR SPACE SAVER

WOLFF luffer – peak performance in small spaces.

The WOLFF luffer always aims high and is available from 100 tm up to 1250 tm with hoisting winches from 37 kW up to 132 kW.

The WOLFF luffing jib crane is efficient, space-saving and feels perfectly at home in confined construction sites. It is particularly easy to transport and assemble thanks to its patented design of the tower top-counter jib unit with an extremely compact design.

Convincing in theory but also in practice, the WOLFF luffer features a minimal jib radius made possible by the recessed hinge point of the jib to the tower top. The level-luffing path simplifies the work for the crane operator. Further intelligent features such as the patented slack rope monitoring, standard secondary brakes for the luffing drive and optional secondary brakes for the hoisting drive ensure additional safety.

WELL DESIGNED FROM EVERY ANGLE

Excellent reasons for a genuine WOLFF.

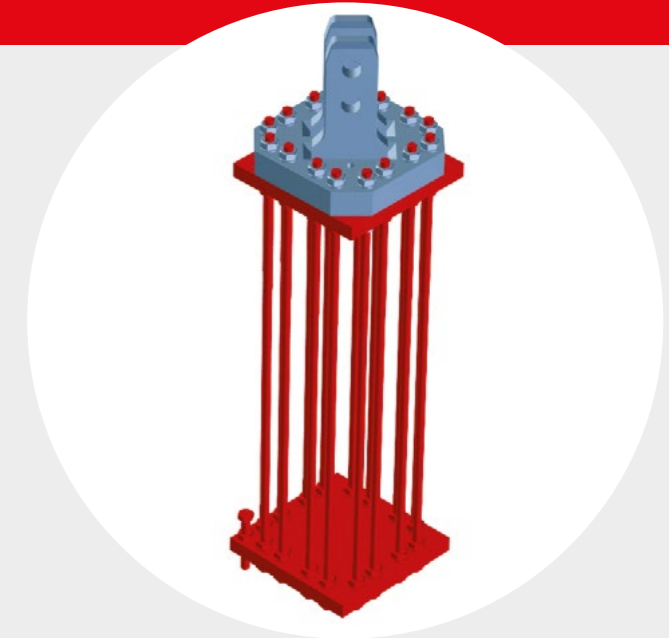
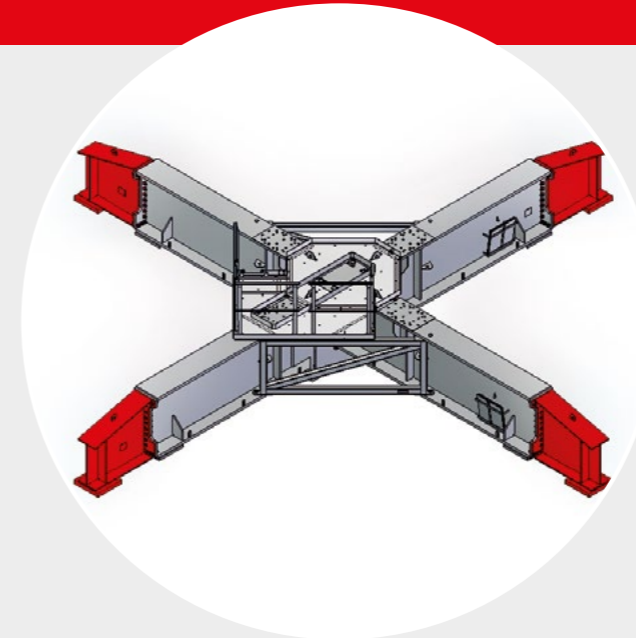
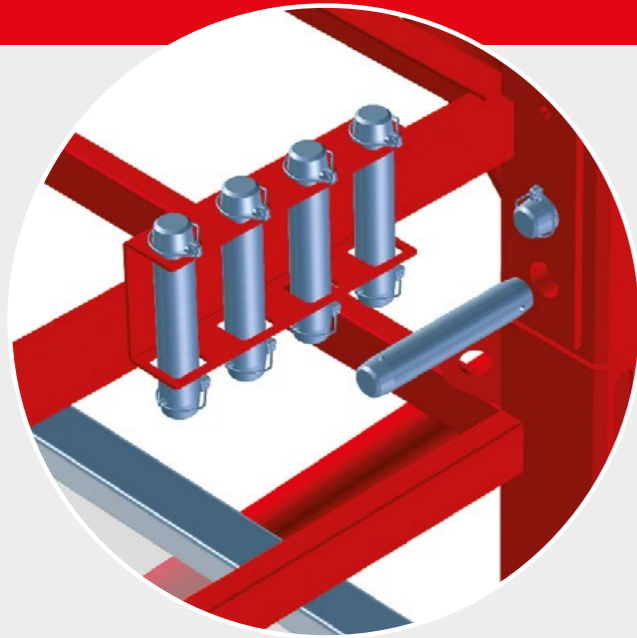

Fast. Reliable. Safe.
The WOLFF pin connection.

Crane assembly must be quick and secure. Thanks to the unique pin connection system, WOLFF cranes are not only the safest tower connections on the market, but also extremely quick and easy to assemble. It doesn't get easier or more reliable than this.

Modular. Variable.
A Safe Investment.
The WOLFF tower system.

Endless possibilities and always a solution that fits perfectly. With WOLFFKRAN, you can combine tower elements of various sizes and strengths thanks to the respective adapter and connection pieces. Your advantage? You do not require a particular tower system for each individual crane, but can flexibly use your existing tower elements. That's another reason why WOLFF is so cost-effective.

Efficient. Flexible. Clever.
The cross frame with
extension beams.

Flexibility and efficiency already pay off on the ground. Every tower element fits on WOLFFKRAN cross frames, regardless of its size. Extension beams are available for the cross frame to accommodate larger tower dimensions. Additional applications, such as portals and under-carriages for the use on rails can also be attached to the cross-frame. The cross frame by WOLFFKRAN is a genius all-rounder.

Simple. Quick. Beneficial.
An economical modular system
for foundation anchoring.

Foundations are often expensive, but that's not the case with a WOLFF crane. The foundation anchor of a WOLFF crane is constructed modularly: the high quality spigot set can be unscrewed and reused multiple times – leaving only the lower-cost anchor in the foundation. It's not only easier, but also more cost effective.

KNOW-HOW DOWN TO THE TINIEST DETAIL

Even more good reasons for a genuine WOLFF.

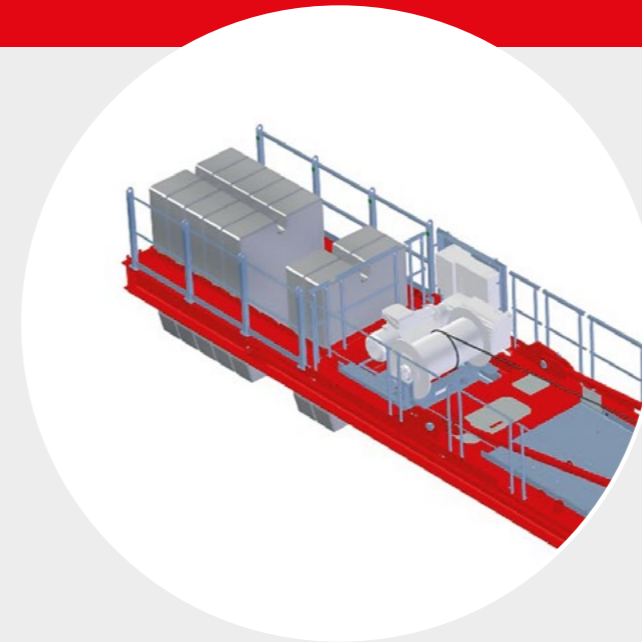

Series Standard.
Strong. Efficient.
WOLFF Boost for more power.

Sometimes even the strongest need a boost. With WOLFF cranes, anything is possible. The series standard boost function offers 10% more power and load capacity. The new control software automatically determines when and how WOLFF Boost is available to the crane operator. WOLFF Boost is not an overload hoist, but rather an integrated functionality of normal crane operation without time restrictions or decreasing safety.

Compact. Convenient.
Functional. The cabin with
a panoramic view.

The workplace should be a place of inspiration. Therefore, WOLFF has redesigned the crane cabin to provide even better visibility and improved interior climate. An ergonomic seat and smooth-running master switches offer additional fatigue-free features. Controls support the crane operator at all times, plus important data is made available on an easy to read 7-inch touch screen display. Features such as radio, hands-free module and drinks cooler are standard and can be upgraded to include air conditioning upon request.

Logical. Practical. Orderly.
The standardized counter
weight blocks.

Good planning goes a long way. That's why WOLFFKRAN has developed a very sophisticated, efficient and orderly counter weight system. Depending on the crane size, all concrete counter weights are uniformly either 2.05 or 2.7 tonnes heavy. This prevents the likelihood of confusion and simplifies storage, planning and transportation.

Understandable. Future Proof.
Cloud Based. WOLFFLink portal
for complete transparency.

Always be in the know. With WOLFFLink portal, you always have an overview of your crane, regardless of its location. The new WOLFFLink portal enables you to view all relevant data online via a secure mobile connection for every WOLFF crane in your fleet. Signals of any malfunction can be automatically reported, if desired. Access data via PC, tablet or smartphone and gain full control and insight into maintenance, operating data and diagnostic profiles. Thus, keeping control over your entire fleet of cranes.

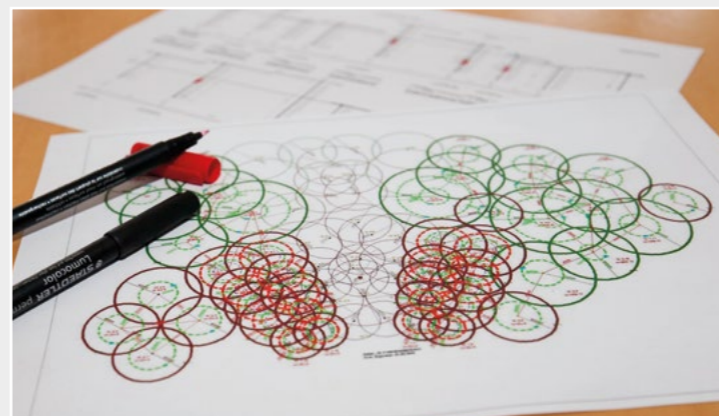

MORE POWER. MORE EFFICIENCY. EVERYTHING FROM WOLFFKRAN.

You have a WOLFF. We have the all-round service.

A WOLFF knows its territory. That's why WOLFFKRAN supports you from the very beginning with our comprehensive range of consulting and support services:

- CAD-supported construction and planning
- Individual static calculations
- Development of customized solutions/special calculations
- Transport and on-site assembly by our teams located in Europe, the Middle East and North America
- Skilled and professional maintenance, service and repairs in our WOLFFKRAN plants in Germany, as well as our offices worldwide
- Maintenance contracts
- Possibility of on-line configuration for planning devices
- Extensive training for your employees
- Global parts network sent direct from our logistics centre in Germany

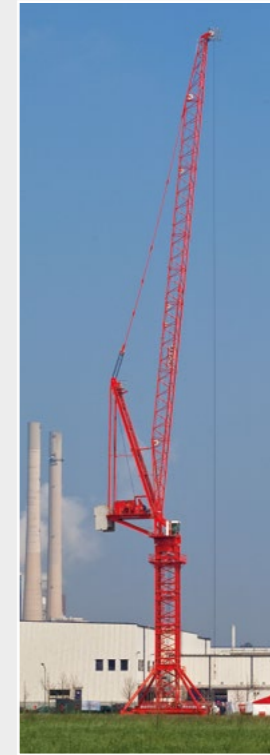
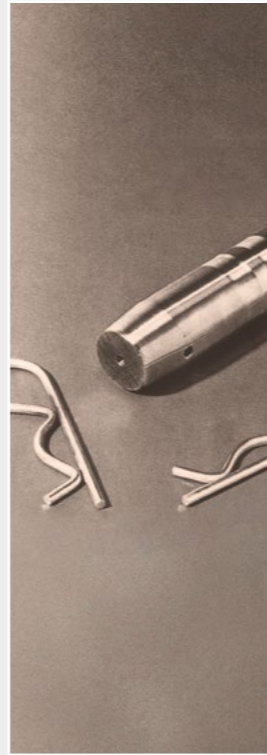

1854

Founding of the iron foundry Friedrich August Wolff in Heilbronn.

1913

WOLFFKRAN presents the first modern tower crane to the world in Leipzig.

1928

WOLFFKRAN manufactured the first saddle jib tower crane with an electrical trolley.

1963

Introduction of the original WOLFF pin connection.

1989

WOLFFKRAN presents the first crane with PLC controls.

1993

WOLFFKRAN introduces the first crane with frequency control drives.

1995

WOLFFKRAN is the first manufacturer to introduce the horizontal load path for luffing cranes.

2009

Introduction of the BIG WOLFF 1250 B, the strongest WOLFF crane ever made.

2013

Introduction of the WOLFF 700 B custom, designed for the assembly of wind turbines.

ENGINEERING AND QUALITY “MADE IN GERMANY”

You have requirements. We fulfil them.

Founded in 1854 as an iron foundry, WOLFFKRAN presented the first fast-assembly, mobile tower crane to the world in 1913. The date marks the beginning of WOLFFKRAN's ongoing success as a leading technological manufacturer of tower cranes to date.

Today, WOLFFKRAN characterises the construction industry – from San Francisco to Hamburg and onward to Melbourne. Our basic principles, however, remain true to WOLFFKRAN: masterful engineering, in-depth customer service and highest German quality.

A WOLFF is quintessentially German. To date, we research and completely develop our products in-house. Each and every WOLFF crane is manufactured exclusively in our factories in Heilbronn and Luckau. More than 150 years of experience and 800 motivated employees provide our customers the high security and technological standards, for which WOLFFKRAN is renowned.

We are specialists in tower cranes. Thanks to many branch offices, extensive planning and on-site services, we know our customers' daily requirements, tasks and business operations. This invaluable knowledge is continually integrated into our development.

We are the technological leader. Our products feature numerous innovations developed by our engineers, such as our secure pin connections, PLC controls and horizontal loading paths. That's what makes working with a WOLFF so comfortable, secure and particularly cost-effective.

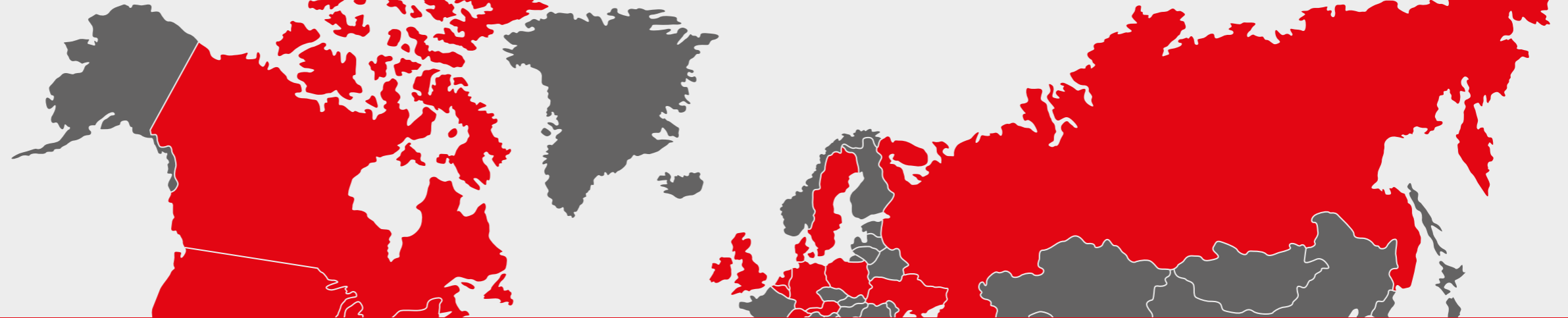

GERMANY: HEILBRONN | BERLIN | DORTMUND | HAMBURG | LUCKAU | MUNICH | AUSTRIA: VIENNA

SWITZERLAND: ZUG | DÄLLIKON | BOUDRY | UK: SHEFFIELD | BELGIUM: BORNEM | OSTENDE

USA: MASPETH | BRIDGEWATER | CANADA: CALGARY | UAE: DUBAI | ABU DHABI | SAUDI ARABIA: JEDDAH | CHINA: HONG KONG



SPECIALISTS FOR CUSTOMER ENGAGEMENT

You have questions. We have the answers.

With five branches in Germany alone and our own subsidiaries and select partners strategically situated around the world, WOLFFKRAN is always right there where you need them.

Close cooperation, continual extensive training and high quality standards portray our distribution network. As a WOLFFKRAN customer, you receive advice, planning, maintenance and repairs from one, specialized source.

Our experienced local team members know your requirements and will ensure that your WOLFF crane pays off over its life cycle.



61000358 - 10/2020

WOLFFKRAN INTERNATIONAL AG

Baarermattstrasse 6
6340 Baar
SWITZERLAND
Phone +41 41 766 85 00
Fax +41 41 766 85 99
info@wolffkran.com

www.wolffkran.com

Der Leitwolf.
The leader of the pack.

